

CENTRIS veoHz

RADIO CENTRAL MOTOR

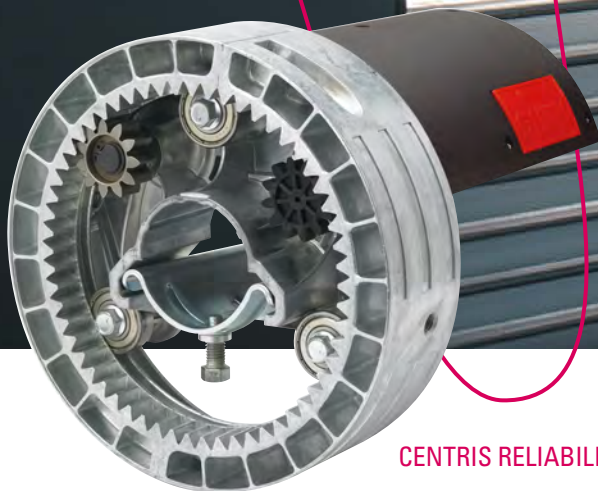

CENTRIS RELIABILITY WITH THE COMFORT OF RADIO CONTROL, IN COMPLIANCE WITH STANDARDS

- **Unique on the market**, the new SIMU central motor with in-built radio receiver can be controlled remotely from a SIMU veoHz radio transmitter.
- **Faster installation**: the control is wireless. No control box or key switch or external receiver to wire, therefore no hole in the walls or cable raceways to lay.
- **Simplified setting of the limit switches** from the radio transmitter. Just few clicks is all it takes to set the limit switches from the ground. No need to access the motor!
- **CE compliant system**, guaranteed by an "in sight" control of the motor in deadman mode.
- **Secure control commands**, transmitted by encrypted orders and rolling code (16 million possible combinations).
- **A partial opening memorization**: simply press the stop button and the shutter goes to the recorded mid-height position to show that the store is about to open.
- **Detection of locked door**, protecting the installation in case of unlocking oblivion.



MOTOR CENTRIS veoHz

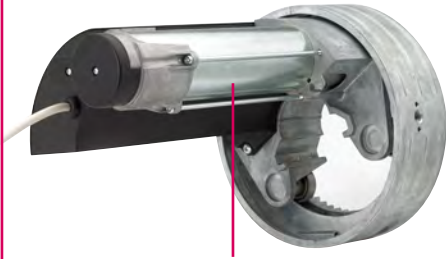

The nominal torque is guaranteed for the entire operating cycle with no loss of power.

Built-in brake inside the motorization ensuring an immediate stop of the closure.

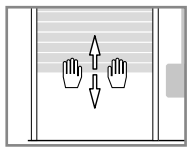

Declutching system which acts directly on the gearbox for easy manual operation

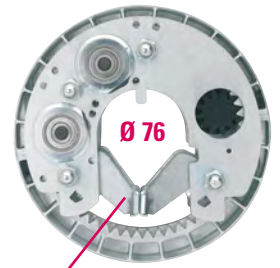
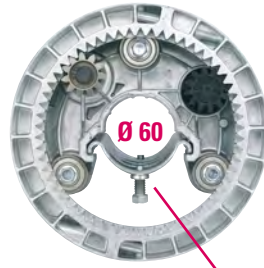

Patented fixing systems ensuring the motor is held solidly and durably.

Radio receiver in-built in the motor.



Electronic limit switch system fully protected in a box.

Bonus: After releasing the declutching or in the event that there is no electricity for a long period, this unique system automatically returns to its limit switches.

TECHNICAL CHARACTERISTICS

LIMIT SWITCH	Electronic system controlled by a SIMU veoHz radio transmitter
POWER SUPPLY	230 Volts - 50 Hz
RADIO FREQUENCY	434MHz
SECURE COMMUNICATION	Encryption of the control commands + rolling code with 16 million possible combinations
RANGE	Adjustable in + or - 5m in open field
MAXIMUM NUMBER OF TRANSMITTERS	12
SPEED	10 rpm
LIMIT SWITCH CAPACITY	20 Trs
AMBIANT WORKING TEMPERATURE	from -10°C to +40°C and exceptionally from -20°C to +60°C
THERMAL CUT-OUT	4 minutes
NUMBER OF CYCLES PER DAY	10 (non-consecutive)
PROTECTION INDEX	IPX4
STANDARD CABLE	grey, H05 VVF, 4m long

MOTOR SELECTION CHARTS

The choice of motor is based on:

- the weight of the shutter or grille
- the diameter of the central tube (Ø60 or Ø76)
- the diameter of the spring wire coil (Ø200, Ø220 or Ø240)

MOTORS	CROWN Ø 200		CROWN Ø 220		CROWN Ø 240	
	Nominal	Max	Nominal	Max	Nominal	Max
CENTRIS veoHz M	160 KG	200 KG	150 KG	190 KG	-	-
CENTRIS veoHz L	220 KG	250 KG	200 KG	230 KG	180 KG	210 KG
CENTRIS veoHz XL	-	-	255 KG	270 KG	230 KG	245 KG

The load graphs and functional limits are provided for illustration purposes only and vary depending on the characteristics of every installation. Under no circumstances may the seller or manufacturer be held liable for the information contained therein. Please consult us about any special cases.

TECHNICAL DATA

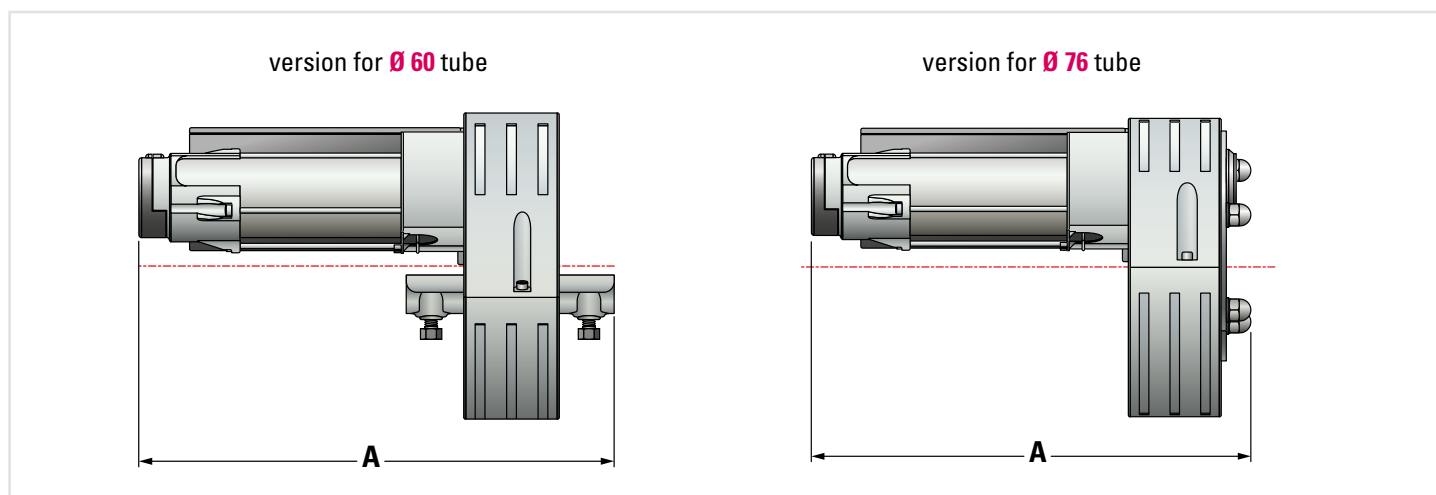

Power supply 230V - 50Hz

NAME	TORQUE	POWER	CURRENT	BRAKE & DECLUTCHING	TUBE DIAMETER	CROWN	WEIGHT	LENGTH A	REFERENCE (x 1)
CENTRIS veoHz M	75 Nm	300 W	1,3 A	yes	60 mm	200 mm	7 kg	372 mm	2008855
CENTRIS veoHz M	75 Nm	300 W	1,3 A	yes	60 mm	220 mm	7 kg	372 mm	2008856
CENTRIS veoHz L	100 Nm	360 W	1,6 A	yes	60 mm	200 mm	7 kg	372 mm	2008859
CENTRIS veoHz L	100 Nm	360 W	1,6 A	yes	60 mm	220 mm	7 kg	372 mm	2008860
CENTRIS veoHz L	100 Nm	360 W	1,6 A	yes	76 mm	220 mm	7 kg	372 mm	2008863
CENTRIS veoHz XL	140 Nm	450 W	2 A	yes	60 mm	220 mm	7 kg	372 mm	2008864
CENTRIS veoHz XL	140 Nm	450 W	2 A	yes	76 mm	220 mm	7 kg	372 mm	2008866
CENTRIS veoHz XL	140 Nm	450 W	2 A	yes	76 mm	240 mm	7 kg	372 mm	2008867

Multiple packaging x27 on request

COMPATIBLE RADIO CONTROLS



TSA 3B veoHz *
Remote control - 1 channel
Ref. 2008576 - by 1
Ref. 2008836 - by 27



Wall support
Ref. 2008886 by 10



Control box veoHz
Ref. 2008924



All our CENTRIS veoHz motors are delivered with a TSA 3B veoHz * remote control
Note: CENTRIS veoHz is not compatible with SIMU-Hz transmitters

BONUS OF SIMU veoHz :

A SYSTEM 100% COMPLIANT WITH CE STANDARDS



- Embedded security software in the motor, software class B, electronic protection circuits, in accordance with the requirements of EN 60335-2-103.
- Limited radio range, to guarantee an in sight control of the shutter.
- Choice of control mode (deadman or mixed), for installation in accordance with standards whatever the type of curtain / grid.

ACCESSORIES

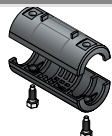
PRODUCT	TUBES	DESCRIPTION	REFERENCE
	Ø 34 mm	Adaptation kits	9015363
	Ø 42 mm	Adaptation kits	9015364
	Ø 48 mm	Adaptation kits	9015366

- These kits allow you to mount CENTRIS veoHz onto a mechanism using a Ø 34, Ø 42 or Ø 48 mm tube.
- Used with CENTRIS veoHz : M or L for a Ø 60-mm tube.

PRODUCT	CROWN	DESCRIPTION	REFERENCE x 10
	diameter 200 to 220 mm or diameter 220 to 240 mm	Adaptations kits for crown. Screws and washers included.	9016731

- Sachet of 10 adaptations

PRODUCT	LENGTH	DESCRIPTION	REFERENCE
	6 meters	Declutching kit with pistol handle	9015176

- Declutching kit: one handle, a 6-m cable, technical instructions

PRODUCT	LENGTH	DESCRIPTION	REFERENCE
	6 meters	Declutching kit with classic handle with screwing / unscrewing	9017544

- This declutching kit (one handle, a 6-m cable, technical instructions) is delivered as standard with CENTRIS veoHz.
- The reference below will be used in the context of the after sales service.

